



INSTRUCTION MANUAL

VHF TRANSCEIVER

IC-F11/S

UHF TRANSCEIVER

IC-F21/S

This device complies with Part 15 of the FCC Rules. Operation is subject to the condition that this device does not cause harmful interference.

Icom Inc.



SAFETY TRAINING INFORMATION



WARNING

Your Icom radio generates RF electromagnetic energy during transmit mode. This radio is designed for and classified as “Occupational Use Only”, meaning it must be used only during the course of employment by individuals aware of the hazards, and the ways to minimize such hazards.

This radio is NOT intended for use by the “General Population” in an uncontrolled environment.

This radio has been tested and complies with the FCC RF exposure limits for “Occupational Use Only.” In addition, your Icom radio complies with the following Standards and Guidelines with regard to RF energy and electromagnetic energy levels and evaluation of such levels for exposure to humans:

- FCC OET Bulletin 65 Edition 97-01 Supplement C, Evaluating Compliance with FCC Guidelines for Human Exposure to Radio Frequency Electromagnetic Fields.
- American National Standards Institute (C95.1 – 1992), IEEE Standard for Safety Levels with Respect to Human Exposure to Radio Frequency Electromagnetic Fields, 3 kHz to 300 GHz.
- American National Standards Institute (C95.3 – 1992), IEEE Recommended Practice for the Measurement of Potentially Hazardous Electromagnetic Fields – RF and Microwave.



CAUTION

To ensure that your exposure to RF electromagnetic energy is within the FCC allowable limits for occupational use, always adhere to the following guidelines:

- **DO NOT** operate the radio without a proper antenna attached, as this may damage the radio and may also cause you to exceed FCC RF exposure limits. A proper antenna is the antenna supplied with

this radio by the manufacturer or an antenna specifically authorized by the manufacturer for use with this radio.

- **DO NOT** transmit for more than 50% of total radio use time (“50% duty cycle”). Transmitting more than 50% of the time can cause FCC RF exposure compliance requirements to be exceeded. The radio is transmitting when the “TX indicator” lights red. You can cause the radio to transmit by pressing the “PTT” switch.
- **ALWAYS use** Icom authorized accessories (antennas, batteries, belt clips, speaker/mics, etc). Use of unauthorized accessories can cause the FCC RF exposure compliance requirements to be exceeded.
- **ALWAYS keep** the antenna at least 2.5 cm (1 inch) away from the body when transmitting and only use the Icom belt-clips, listed in p. 21, when attaching the radio to your belt, etc., to ensure FCC RF exposure compliance requirements are not exceeded. To provide the recipients of your transmission the best sound quality, hold the antenna at least 5 cm (2 inches) from mouth, and slightly off to one side.

The information listed above provides the user with the information needed to make him or her aware of RF exposure, and what to do to assure that this radio operates within the FCC RF exposure limits of this radio.

Electromagnetic Interference/Compatibility

During transmissions, your Icom radio generates RF energy that can possibly cause interference with other devices or systems. To avoid such interference, turn off the radio in areas where signs are posted to do so. **DO NOT** operate the transmitter in areas that are sensitive to electromagnetic radiation such as hospitals, aircraft, and blasting sites.

FOREWORD

Thank you for purchasing the IC-F11/S, F21/S FM transceiver.

READ ALL INSTRUCTIONS carefully and completely before using the transceiver.

SAVE THIS INSTRUCTION MANUAL—This instruction manual contains important operating instructions for the transceiver.

IMPORTANT

⚠ **CAUTION! NEVER** hold the transceiver so that the antenna is very close to, or touching exposed parts of the body, especially the face or eyes, while transmitting. The transceiver will perform best if the microphone is 2 to 4 in. (5 to 10 cm) away from the lips and the transceiver is vertical.

⚠ **CAUTION! NEVER** operate the transceiver with a headset or other audio accessories at high volume levels.

⚠ **CAUTION! NEVER** short the terminals of the battery pack.

DO NOT push the PTT when not actually desiring to transmit.

AVOID using or placing the transceiver in direct sunlight or in areas with temperatures below +14°F (−10°C) or above +122°F (+50°C).

DO NOT modify the transceiver for any reason.

KEEP the transceiver from the heavy rain, and **Never** immerse it in the water. The transceiver construction is **water resistant**, not water proof.

The use of non-Icom battery packs/chargers may impair transceiver performance and invalidate the warranty.

FCC caution: Changes or modifications to this transceiver, not expressly approved by Icom Inc., could void your authority to operate this transceiver under FCC regulations.

TABLE OF CONTENTS

SAFETY TRAINING INFORMATION	i-ii
FOREWORD	iii
IMPORTANT	iii
TABLE OF CONTENTS	iv
1 PANEL DESCRIPTION	1-3
■ Switches, controls, keys and connectors	1-2
■ LED indicator	3
2 ACCESSORIES	4
3 BATTERY PACKS	5-11
■ Battery pack replacement	5
■ Battery cautions	6
■ Battery charging	7-9
■ Charging NOTE	10
■ Battery case (Option)	11
4 PROGRAMMABLE FUNCTIONS	12-16
■ General	12
5 CONVENTIONAL OPERATION	17-18
■ Receiving and transmitting	17
■ Call procedure	18
■ Transmitting notes	18
6 CLONING	20
7 OPTION	21-22

1 PANEL DESCRIPTION

■ Switches, controls, keys and connectors

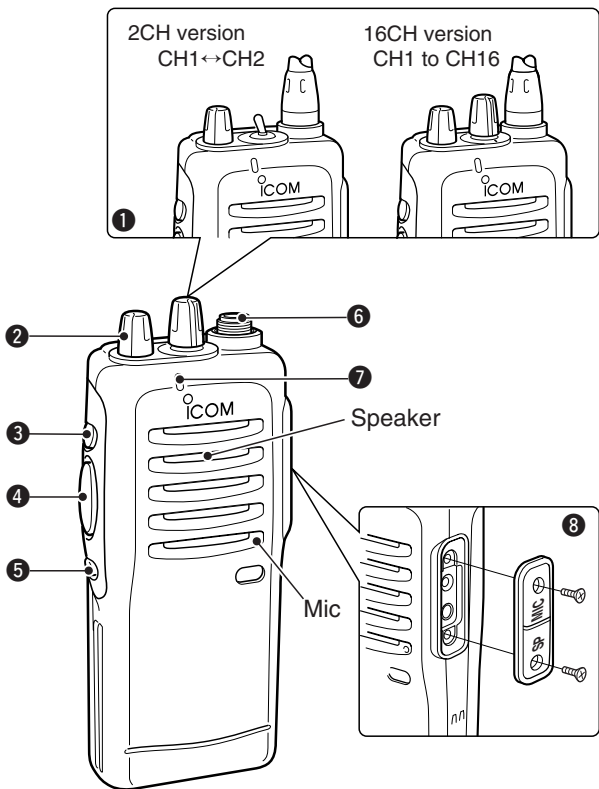

① CHANNEL SELECTOR/SW [CH]

- 2CH version : Toggle the CH switch to select CH1 or CH2.
- 16CH version: Turn the selector knob to select the programmed operating channel.

② VOLUME CONTROL [OFF/VOL]

Turns power ON and adjusts the audio level.

③ DEALER-PROGRAMMABLE KEY [Upper]

Can be programmed for one of several functions by your Icom dealer.

④ PTT SWITCH [PTT]

Push and hold to transmit; release to receive.

⑤ DEALER-PROGRAMMABLE KEY [Lower]

Can be programmed for one of several functions by your Icom dealer.

⑥ ANTENNA CONNECTOR

Connects the supplied antenna.

⑦ TX/RX INDICATOR LED (see p. 3)

- Lights red while transmitting.
- Lights green while receiving a signal, or squelch is open.

⑧ [SP]/[MIC] JACK

Connects optional speaker-microphone.

NOTE: Above functions depend on pre-setting.

◇ **Programmable key reference** ([Red] depends on version.)

Red	
Upper	
Lower	

1 PANEL DESCRIPTION

■ LED indicator

The TX/RX indicator LED indicates several more information as follows;
(Ref.; R=Red, G=Green, O=Orange)

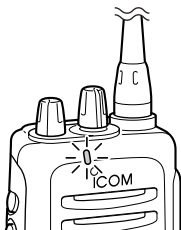

- TX: Turns Red while transmitting a signal.



- RX: Turns Green while receiving a signal.

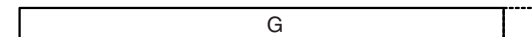

- Call LED (ON): When receiving a matched 2/5TONE.



- Call LED (Blink): When receiving a matched 2/5TONE.



- Fast/Slow scan: Blinks while Fast/Slow scan is activated.



- Low BATT1: You should charge the battery. (blinks slowly)



- Low BATT2: You must charge the battery. (blinks fast)



- TX low BATT1: Low BATT1 was detected during TX mode.



- TX low BATT2: Low BATT2 was detected during TX mode.



ACCESSORIES 2

■ Accessory attachment

◇ Supplied accessories

The transceiver comes supplied with the following accessories.

- ① Flexible antenna
- ② Belt clip (w/screws)

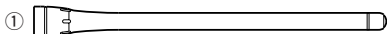

◇ Antenna

The antenna screws onto the transceiver as illustrated right.

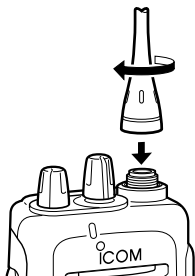

◇ Belt clip

Attach the belt clip to the transceiver as illustrated below.

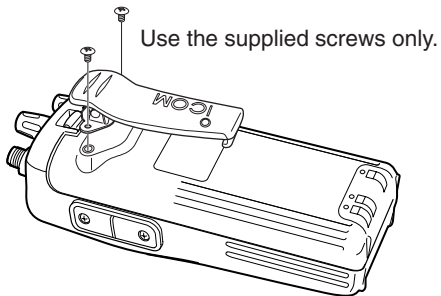

3 BATTERY PACKS

■ Battery pack replacement

Before replacing the battery pack, the volume control **MUST** be rotated fully counterclockwise, until a click is heard, to **turn the power OFF**.

- Slide the battery release forward, then pull the battery pack upward with the transceiver facing away from you.

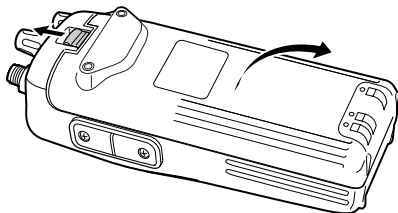

◇ BATTERY PACKS

Battery pack	Voltage	Capacity	Charging period		Battery life* ²
			BC-146	BC-144N* ¹ , BC-119N or BC-121N	
BP-208N* ⁴	Battery case for AA (LR6) × 6 alkaline		N/A	N/A	—* ³
BP-209N	7.2 V	1100 mAh	12 hrs.	1.5 hrs.	8.5 hrs.
BP-210N	7.2 V	1650 mAh	18.5 hrs.	2.0 hrs.	13 hrs.
BP-211N	7.4 V	1800 mAh	N/A	2.0 hrs.	14 hrs.
BP-222N* ⁵	7.2 V	600 mAh	6.5 hrs.	1.0 hrs.	4.5 hrs.* ⁵

*¹ BP-211N is not available.

*² Operating period is calculated under the following conditions;
Tx : Rx : standby = 5 : 5 : 90

*³ Operating period depends on the alkaline cells used.

*⁴ Output power is automatically reduced to 1 W to retain sufficient power in case of an emergency, etc.

*⁵ Operating period measured with the 2 W model.

■ Battery cautions

- **CAUTION! NEVER** short the terminals of the battery pack (or charging terminals of the transceiver). Also, current may flow into nearby metal objects such as a necklace, so be careful when placing battery packs (or the transceiver) in handbags, etc. Simply carrying with or placing near metal objects such as a necklace, etc. causes shorting. This will damage not only the battery pack, but also the transceiver.
- **NEVER** incinerate used battery packs. Internal battery gas may cause an explosion.
- **NEVER** immerse the battery pack in water. If the battery pack becomes wet, be sure to wipe it dry **BEFORE** attaching it to the transceiver.
- **Clean** the battery terminals to avoid rust or miss contact.
- **Keep** battery contacts clean. It's a good idea to clean battery terminals once a week.

If your Ni-Cd or Ni-MH battery pack seems to have no capacity even after being charged, completely discharge it by leaving the power ON overnight. Then, fully charge the battery pack again. If the battery pack still does not retain a charge (or only very little charge), a new battery pack must be purchased.

◇ Recycling information (U.S.A. only)



The Ni-Cd battery (BP-209N or BP-222N) that you have purchased is recyclable. At the end of its life, under various state and local laws, it may be illegal to dispose of this battery into the municipal waste stream. Call 1-800-822-8837 for battery recycling options in your area or contact your dealer.

3 BATTERY PACKS

■ Battery charging

◇ Rapid charging with the BC-144N+AD-99N

The optional BC-144N provides rapid charging of optional battery packs.

The following are additionally required:

- One AD-99N (depends on version.).
- An AC adapter (may be supplied with the BC-144N depending on version).

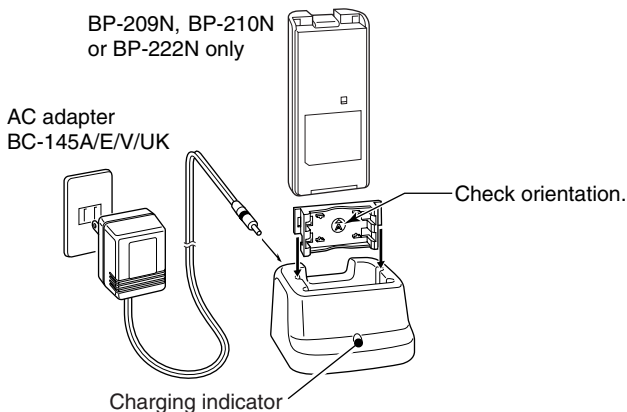

◇ Rapid charging with the BC-144N+AD-99N

BP-209N, BP-210N or BP-222N is attached to the transceiver.

Turn power OFF

AC adaptor
BC-145A/E/V/UK

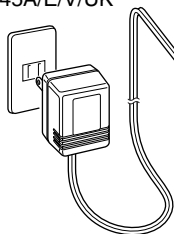

Charging indicator

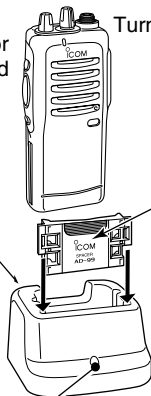

Check orientation and the spacer combination as follows.

◇ Spacer combination.

- Be sure to attach the spacer (Spacer B/C) to the adapter (Spacer A) with the orientation as illustrated in the diagram at right.
- Attach the spacer (Spacer B/C) to the adapter with the orientation of the stamp “**Ⓒ**” pointing up.

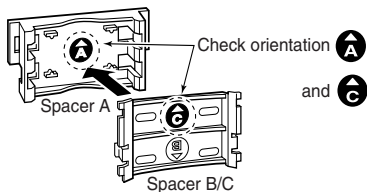

NOTE: Push the notch carefully when remove the spacer from the adapter.

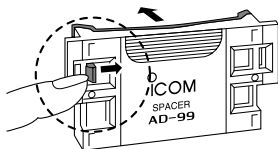

3 BATTERY PACKS

◇ Rapid charging with the BC-121N+AD-101

The optional BC-121N allows up to 6 battery packs to be charged simultaneously. The following are additionally required.

- Six **AD-101**
- An AC adapter (may be supplied with the BC-121N depending on version).

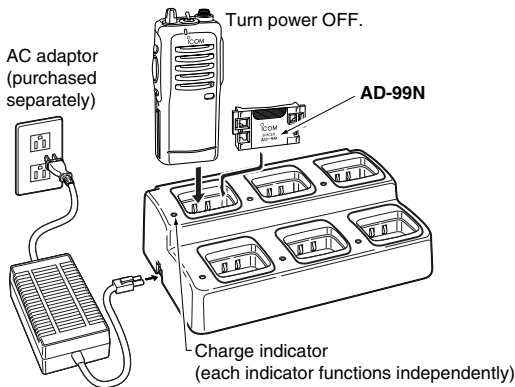

◇ Regular charging with the BC-146

The optional BC-146 provides regular charging of optional battery pack with/without transceiver.

The following is additionally required:

- An optional AC adapter. (A charging spacer is supplied with BC-146.)

Turn power OFF.

Check orientation for correct charging. (Insert together with charging adapter.)

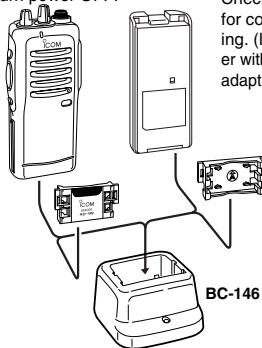

■ Charging NOTE

Prior to using the transceiver for the first time, the battery pack must be fully charged for optimum life and operation.

- Recommended temperature range for charging:
+10°C to +40°C (50°F to 140°F).
- Use the supplied charger or optional charger (BC-119N/BC-121N/BC-144N for rapid charging, BC-146 for regular charging) only. **NEVER** use other manufacturers' chargers.

The optional BP-209N, BP-210N, BP-211N or BP-222N battery packs include rechargeable Ni-Cd (Ni-MH: BP-210N, Li-Ion: BP-211N) batteries and can be charged approx. 300 times. Charge the battery pack before first operating the transceiver or when the battery pack becomes exhausted.

If you want to charge the battery pack more than 300 times, the following points should be observed:

- **Avoid overcharging**— batteries must be removed from the charger to stop charging. Batteries should not be charged for more than 15 hours after the LED indicator turns green.
- Use the battery until it becomes almost completely exhausted under normal conditions.

Recommendation for Li-Ion battery packs:

Li-Ion batteries are different from Ni-Cd batteries in that it is not necessary to completely charge and discharge them to prolong the battery life. Therefore, charging the battery in intervals, and not for extended periods is recommended.

◇ Battery pack life

When the operating period becomes extremely short even after charging the battery pack fully, a new battery pack is needed.

NOTE: The charger rapidly charges a battery pack to a specified level, not a completed level, to prevent overcharging. Leave the battery pack in the charger for a few more hours (up to 15 hours; depending on battery condition) after the LED indicator turns green, to charge the battery completely.

3 BATTERY PACKS

■ Battery case (Option)

When using a BP-208N OPTIONAL BATTERY CASE attached to the transceiver, install 6 AA (LR6) size alkaline batteries as illustrated below.

NOTE: Output power is automatically reduced to 1 W to retain sufficient power in case of an emergency, etc.

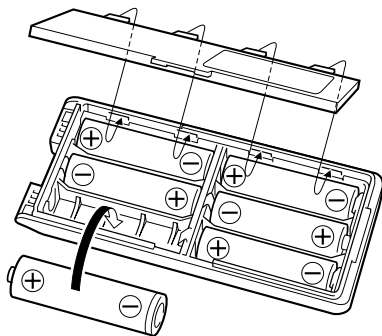

◆ CAUTIONS

- Use **ALKALINE** batteries only.
- **Make sure** all battery cells are the same brand, type and capacity.
- **Never** mix old and new batteries.
Either of the above may cause a fire hazard or damage the transceiver, if ignored.
- **Never** incinerate used battery cells since internal battery gas may cause them to rupture.
- **Never** expose a detached battery case to water.
If the battery case gets wet, be sure to wipe it dry before using it.

■ General

In the following explanations, programmable function names are bracketed, the specific switch used to activate the function depends on programming.

◆ KEY LOCK FUNCTION1/2

This function locks access to all programmable switches (except the switch assigned for the lock function):

Lock1: All Key Lock (except Lock key).

Lock2: Channel select switch Lock.

Push and hold the [Lock1] or [Lock2] switch for 1 sec. to toggle the lock function ON and OFF.

- This function may be inhibited on some channels.

◆ PRIORITY CHANNEL

This function is used to select a pre-programmed channel at the push of a switch.

Push the [PrioA], [PrioA(Rewrite)] or [PrioB] switch to select the priority channel.

- Priority channel is automatically selected.

4 PROGRAMMABLE FUNCTIONS

◇ SCAN FUNCTION

The scan function allows you to search a pre-programmed group of channels for signals.

Push the [Scan] switch to start/stop scan.

- Scan pauses on a channel when receiving a signal.
- “Lockout SCAN” (pre-programmed list SCAN) or “Priority SCAN” can be pre-programmed.
- When the “Power-save function” is activated, the transceiver checks all pre-programmed channels then returns to the “Power-save function” again.

◇ HIGH/LOW POWER OUTPUT

This function selects high or low power for a channel.

Push the [High/Low] switch to toggle between high and low power.

◇ MONITOR AUDIBLE FUNCTION

The monitor function allows you to open the transceiver's squelch manually to check whether a channel is busy or not. The transceiver has 2 conditions for receive standby:

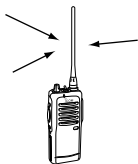

All signals are received

Audible condition:

This condition mutes audio **ONLY** when no carrier is present. You can receive (or monitor) any signals on a channel.

- Push and hold the [Moni], switch to select the audible condition.

Any audio mute functions are cancelled while pushing the [Moni] switch.

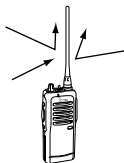

Only signals containing the proper tone are received

Inaudible condition:

This condition mutes **ALL** signals except those directed to you. Therefore you should check a channel's condition (busy or not) with the monitor function before transmitting.

- Push the [Moni] switch momentarily to select the inaudible condition.

◇ TALK AROUND

The talk around function changes duplex channels to simplex channels.

- **Duplex** allows you to contact your base station, repeaters, etc.
- **Simplex** allows you to contact other portable transceivers directly (portable-to-portable contact).

Push the [Talk Around] switch one or more times to toggle the function ON and OFF.

2 PROGRAMMABLE FUNCTIONS

◇ DTMF TRANSMISSION

This function allows you to send a pre-programmed DTMF code to control a repeater, open another transceiver's squelch, etc.

Automatic pre-programmed transmission:

Push the [DTMF Autodial] switch to send a DTMF code.

◇ EMERGENCY FUNCTION

The emergency function allows you to send your ID quickly and easily to your Base Station, etc. in case of emergency.

Push and hold the [Emergency Single/Repeat] switch for 1 sec. to activate the emergency function.

- The transceiver selects a pre-programmed channel, then sends an emergency signal to your Base Station.
- The pre-programmed channel remains selected until a control signal is received from the Base Station, or power is turned OFF.
- The emergency call is repeatedly transmitted at pre-programmed intervals.

◇ MR-CH1, MR-CH2, MR-CH3, MR-CH4

This function temporarily allows you to select one of memory CH1 to CH4, when you push the [MR-CH1] to [MR-CH4] key, respectively.

◆ CODE SQUELCH

This conveniently eliminates unwanted audio and is useful in group activities or security related activities where unwanted output can be a problem. The function is similar to a CTCSS tone squelch.

In order to use the above functions, cloning is necessary via a PC using the optional CS-F11 cloning software. Using this software, the transceiver's model, individual RX Code CH, TX Code CH, Special Tone Link2 (must be 'E') in 5Tone screen, 5Tone Signaling Form in Memory-CH screen, Log, RX C-No, Key&Display, Common AutoReset TimerB, and other settings related to operation can be set. Refer to the HELP file that comes with the CS-F11 CLONING SOFTWARE for available settings.

5 CONVENTIONAL OPERATION

■ Receiving and transmitting

- ▨ **NOTE:** Transmitting without an antenna may damage the transceiver. See p. 4 for antenna attachment.
- ▨ Turn power ON as described on p. 2.

Receiving:

- ① Select a desired channel.
- ② Listen for a transmission and adjust [VOL] to a comfortable listening level.
 - When no transmission is heard, push and hold [Moni] (monitor) while adjusting [VOL] (your transceiver may not be programmed with the monitor function).

The transceiver is now set to receive desired calls on the selected channel.

Transmitting:

Wait for the channel to become clear to avoid interference.

- ③ While pushing and holding [PTT], speak into the microphone at a normal voice level.
 - When a tone signalling system is used, the call procedure described at right may be necessary.
- ④ Release [PTT] to return to receive.

IMPORTANT: To maximize the readability of your transmitted signal, pause a few sec. after pushing [PTT], hold the microphone 10 to 15 cm from your mouth and speak at a normal voice level.

■ Call procedure

When your system employs tone signalling (excluding CTCSS and DTCS), the call procedure may be necessary prior to voice transmission. The tone signalling employed may be a selective calling system which allows you to call specific station(s) only and prevent unwanted stations from contacting you.

- ① Select the desired Tx code channel or 5-tone code according to your System Operator's instructions.
 - This may not be necessary depending on programming.
- ② Push the call switch (assigned to one of the dealer programmable switches: [Upper] and [Lower], etc.).
- ③ After transmitting a 5-tone code, the remainder of your communication can be carried out in the normal fashion.

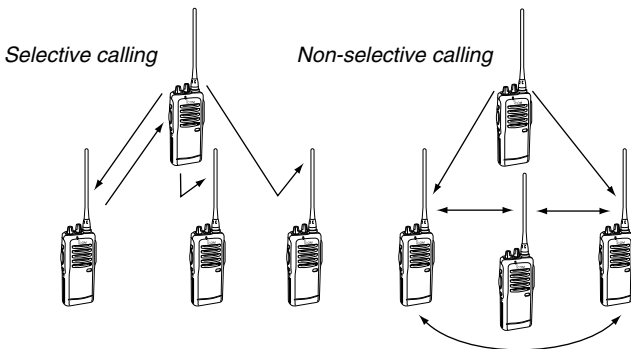

5 CONVENTIONAL OPERATION

■ Setting squelch level

The squelch circuit mutes the received audio signal depending on the signal strength.

- ① While pushing [PTT] and [Lower], turn the transceiver's power on to enter the squelch adjustment mode.
- ② Push [Upper] to increase the squelch level (tight squelch) or [Lower] to decrease the squelch level (loose squelch).
 - Squelch level will be fixed after 1 sec.

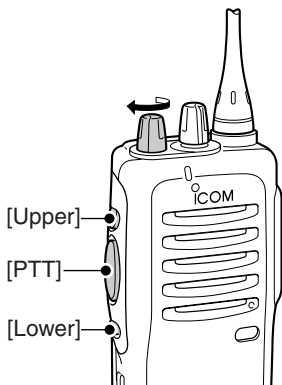

■ Transmitting notes

◆ TIME-OUT TIMER

After continuous transmission for a pre-programmed period, the time-out timer is activated causing the transceiver to stop transmitting, and automatically select receive.

◆ PENALTY TIMER

Once the time-out timer is activated, transmission is further inhibited for a period determined by the penalty timer.

■ Cloning

Cloning allows you to quickly and easily transfer the programmed contents from one transceiver to another transceiver; or data from PC to a transceiver using the optional CS-F11 CLONING SOFTWARE.

◇ Transceiver-to-transceiver cloning

NOTE: ‘Transceiver-to-transceiver cloning’ is available between the same models on 2CH model to 16CH model or the opposite case cannot be cloned.

- ① Connect the optional OPC-474 CLONING CABLE with adapter plugs to the [SP] jack of the master and slave transceivers.
 - The master transceiver is used to send data to the slave transceiver.
- ② While pushing [PTT] and [Upper], turn the transceiver’s power on to enter cloning mode (master transceiver only—power ON only for slave transceiver).
- ③ Push [PTT] on the master transceiver.
 - When cloning is finished, a “Beep” tone is emitted two times.

NOTE: DO NOT push the [PTT] on the slave transceiver during cloning. This will cause a cloning error.
- ④ When cloning is finished, turn power off, then on again to return to normal operation.

◇ PC-to-transceiver cloning

Please refer to the HELP file that comes with the CS-F11 CLONING SOFTWARE.

CAUTION: Imprudent cloning operation causes a cloning error. In such a case, memory contents may be lost. Cloning must then be repeated.

7 OPTION

◇ BATTERY PACKS/CASE

• **BP-208N/BP-209N/BP-210N/BP-211N/BP-222N**

BP-208N : Battery case for 6 AA (LR6) alkaline cells

BP-209N : 7.2 V/1100 mAh Ni-Cd battery pack

BP-210N : 7.2 V/1650 mAh Ni-MH battery pack

BP-211N : 7.4 V/1800 mAh Li-Ion battery pack

BP-222N : 7.2 V/600 mAh Ni-Cd battery pack

◇ RAPID CHARGERS

• **BC-119N** DESKTOP CHARGER + **AD-101** CHARGER ADAPTOR

• **BC-121N** MULTI-CHARGER + **AD-101** CHARGER ADAPTOR (6 pcs.)

• **BC-144N** DESKTOP CHARGER + **BC-145** AC ADAPTOR

◇ REGULAR CHARGERS

• **BC-146** BATTERY CHARGER + **BC-147** AC ADAPTOR

◇ OTHER OPTIONS

• **HM-131L** SPEAKER-MICROPHONE

• **FA-SC56VS/FA-SC57VS/FA-SC73US** STUBBY ANTENNAS

FA-SC56VS: 150–162 MHz

FA-SC57VS: 160–174 MHz

FA-SC73US: 450–490 MHz

• **VS-1L** VOX/PTT CASE + **HS-94/HS-95/HS-97**

HS-94: Ear hook type

HS-95: Neck-arm type

HS-97: Throat microphone

• **HS-51** HEAD SET

Allows you hands-free operation. Includes PTT and TOT.

• **SP-13** EARPHONE

Provides clear receive audio in noisy environments.

• **MB-103/MB-86** BELT CLIPS

MB-103 : Same as that supplied with the transceiver.

MB-86 : Swivel belt clip

• **MB-96N/MB-96F** BELT HANGERS

MB-96N : Swivel belt hanger.

MB-96F : Standard type hanger.

• **AD-98FSC** ANTENNA CONNECTOR CONVERTER

Allows you to connect an external antenna with BNC connector.

- **CS-F11** CLONING SOFTWARE + **OPC-478** CLONING CABLE
Allows you to clone the memory contents of an IC-F11/S, IC-F21/S by PC editing.
- **OPC-474** CLONING CABLE
Cloning cable for transceiver to transceiver

Count on us!



IC-F11S/F21S series

A-6021H-1EX-④

Printed in Japan

© 2001–2007 Icom Inc.

Printed on recycled paper with soy ink.

Icom Inc.

1-1-32 Kamiminami, Hirano-ku, Osaka 547-0003, Japan